

Minor Modifications – light vehicles

Vehicle Standards Instruction G19.10 - October 2018

To modify a vehicle means to change a vehicle (including by adding something to the vehicle) from the manufacturer's specifications for the vehicle. Any modification or fitting of any device to a vehicle must not contravene the requirements of the *Transport Operations (Road Use Management – Vehicle Standards and Safety) Regulation 2010*.

Minor modifications are alterations carried out on production vehicles and are accepted by jurisdictions without certification. Typical minor modifications include the fitting of radios, CD players, wheel trims, and so on.

The following information provides a guide for vehicle owners or vehicle modifiers wishing to perform minor modifications. This VSI applies to light vehicles only.

The modifications listed below can be carried out without certification by an Approved Person or specific approval from the Department of Transport and Main Roads (TMR), unless stated differently. If your modification falls outside of the modifications listed below you should engage the services of an Approved Person or contact TMR for further advice. To find the details of an Approved Person near you, please contact TMR on 13 23 80.

Modifications and Insurance

Making certain modifications to your vehicle may mean that your insurer:

- decides that it is no longer willing to insure your vehicle;
- decides that the insurance premium will need to increase; or
- decides not to accept a claim under the insurance policy, particularly where they have not been advised of the modification and the modification may have contributed to an accident.

TMR is not able to provide advice regarding insurance implications. If you are planning to modify your vehicle, it is recommended that you consult with your insurer, particularly where the modifications may affect its value, safety, performance or appearance.

Modifications and measurement tolerances

Measurement tolerances are provided for enforcement purposes and are applied when measuring dimensions in variable locations during on-road enforcement. The tolerances can vary depending on the nature of the location, such as a sloping or uneven road verge, and may not apply in a controlled workshop environment. All measurements listed in this document are the maximum allowable, and are not to be exceeded when designing or constructing a modification.

Exhaust systems

Exhaust system components such as manifolds, mufflers, and catalytic converters may be modified without specific approval provided they meet the following conditions:

- Exhaust headers (extractors) may be fitted to any motor vehicle, provided:
 - they do not foul any part of the steering, suspension, brake or fuel systems
 - all fittings for emission control equipment (E.G.R. valve, oxygen sensor, pipes and so on) are incorporated to ensure the vehicle maintains compliance with Australian Design Rules (ADRs) for vehicle emissions
 - exhaust systems continue to comply with relevant legislation or ADRs for vehicle noise
 - they bear the correct markings as specified by the ADRs, for example, a trademark or name of the component manufacturer.
- Silencing devices and emission control devices, such as mufflers and catalytic converters, may be replaced, provided:
 - they do not foul any part of the steering, suspension, brake or fuel systems
 - they bear the correct markings as specified by the ADRs, for example, a trademark or name of the component manufacturer.



- Exhaust systems must continue to comply with relevant legislation or ADRs for vehicle noise.
- The exhaust outlet must extend at least 40mm beyond the furthest outboard or rearmost joint of the floor pan that is not continuously welded or permanently sealed and which could permit direct access of exhaust gases to the passenger compartment, but not beyond the perimeter of the vehicle when viewed in plan.
- The exhaust outlet, if to the side of the vehicle, must discharge to the right hand side of the vehicle and horizontally or at an angle of not more than 45 degrees below the horizontal.
- The exhaust outlet, if to the rear of the vehicle, must discharge horizontally or at an angle of not greater than 45 degrees below the horizontal.
- All exhaust and muffler systems must be free of any leaks or mechanical faults and should be adequately supported.
- All replacement silencing components, such as mufflers and exhaust manifolds, must comply with either the information specified on the vehicle's original external noise level label, the ADRs (full testing and new labelling required) or the [Transport Operations \(Road Use Management - Vehicle Standards and Safety\) Regulation 2010](#), whichever is applicable to the vehicle's date of manufacture.

Engines

Replacement Engines

Replacement engines that are offered by the manufacturer as an optional engine for that model of vehicle may be fitted without specific approval. For such conversions, all components, including suspension and brakes, must be identical to those of a vehicle originally produced with the optional engine.

For further information please refer to the [LA section](#) of the National Code of Practice for Light Vehicle Construction and Modification.



Fuel Systems

Non-standard fuel delivery systems, such as multiple and/or replacement carburetors, or fuel injection system components may be fitted without specific approval provided the vehicle continues to comply with the emission requirements of the Australian Design Rules (ADRs) applicable at the vehicle's date of manufacture and does not increase the engine power by more than 20%.



Aftermarket / Re-mapped Engine Management Computers

The use of aftermarket (not supplied by the original vehicle manufacturer) or re-mapped engine management computers is permitted without specific approval, provided the vehicle continues to comply with the emission requirements of the ADRs applicable at the time of the vehicle's manufacture. Often the aftermarket engine management computer manufacturer or the company re-mapping the unit have undertaken ADR emission testing and can supply evidence of compliance. However, where a modification increases the engine power by more than 20%, the modification must be certified by an Approved Person.

For further information please refer to the [LA section](#) of the National Code of Practice for Light Vehicle Construction and Modification.

Nitrous Oxide

The fitting of nitrous oxide injection systems is not permitted under any circumstances. This includes a partial installation or a disconnectable nitrous oxide system being fitted to a vehicle.

Fuel System

The following items are considered as minor modifications and can be performed without specific approval:

- fitting replacement fuel lines
- fitting additional fuel filters
- fitting alternative fuel pumps
- fitting a manufacturer's optional fuel system.

Air Filters

Fitting a replacement air filter, including pod-type air filters, is considered a minor modification and does not require specific approval. When fitting a replacement air filter, you must ensure it is securely attached to the vehicle and does not cause an increase in noise from the air intake system. To resolve this issue, the air filter element may have to be effectively encased or boxed-in.

In addition to the above requirements, the vehicle's gaseous emissions must not be adversely affected. As such, all emission sensors must remain fitted and connected in a similar location to the original vehicle manufacturer's design. It is also important to be aware that some types of sensors give false readings when oil soaked air filters are used. When oil soaked air filters are used, confirmation should be sought from the manufacturer about the effect on the exhaust emissions.

Please Note: Air filters should be flame retardant.

Gear Drives and Belts

The fitment of non-standard gear drives and auxiliary belt drives is considered a minor modification which does not require specific approval, provided they do not result in an increase in noise levels.

Blow-off Valves

The fitment of a blow-off valve to a vehicle is considered a minor modification which does not require specific approval, provided it vents back into the vehicle's induction system. Blow-off valves that vent directly to the atmosphere must not be fitted.

Turbo Wastegates

The fitment of a wastegate to a vehicle is considered a minor modification which does not require specific approval, provided it vents gases into the exhaust system upstream of the mufflers and/or catalytic converter. Wastegates that vent gases directly into the atmosphere must not be fitted.

Please Note: Modifications to the engine and engine components that result in an increase in engine power of more than 20% of the original engine power must be certified under the [LA section](#) of the National Code of Practice for Light Vehicle Construction and Modification.

Brakes

Replacement brakes that are offered by the manufacturer as an option for that model of vehicle may be fitted without specific approval. For such conversions, all components must be identical to those of a vehicle originally produced with the optional brakes.

Brake systems modifications must not reduce braking performance or increase the risk of brake failure. Brake discs or drums must not be machined beyond the reconditioning limits set down by the manufacturer.

When brakes are upgraded using components or systems which were not standard options for the vehicle, an Approved Person must be engaged to certify the adequacy of the new system, as issues such as hydraulic fluid sufficiency, balanced braking on all wheels, brake pedal pressure limitations and braking performance must be considered.

For further information please refer to the [LG section](#) of the National Code of Practice for Light Vehicle Construction and Modification.

Vehicle Lifts

Raising of 4WD type vehicles (ADR category MC, NA and NB1 only)

Vehicles with electronic stability control (ESC) are treated the same as vehicles without ESC.

The raising of a vehicle is permitted up to 75mm without certification, testing or specific approval, provided the vehicle continues to comply with all other vehicle standards requirements. The 75mm lift limit can be made up of a maximum of 50mm suspension and/or 25mm tyres only. No body block lift is allowed without certification.

A vehicle lift up to 150mm is permitted with certification by an Approved Person. The maximum 150mm limit can be made up of a maximum of 75mm suspension, 25mm tyres and 50mm body blocks. Tyre lift heights are 50% of the tyre diameter, for example a 25mm tyre lift results from a 50mm increase in tyre diameter. For more information, refer to the section on Tyres and Rims.

For more information refer to the Queensland Code of Practice: Vehicle Modifications.

A vehicle lift over 150mm can only be approved by the Department of Transport and Main Roads. Applications must be submitted for the design of the lift and be accompanied by an engineering report.

For access to the application form refer to <https://www.tmr.qld.gov.au/Safety/Vehicle-standards-and-modifications/Vehicle-modifications/Light-vehicle-modifications>

Table 1 details the internal lift limits (suspension, tyres and body blocks) that apply for 4 wheel drive type vehicles (ADR category MC, NA and NB1). For cars, minivans and station wagons (MA, MB category) please refer to the National Code of Practice for Light Vehicle Construction and Modification.

Table 1 (ESC and non ESC vehicles are treated the same)

Certification	Suspension	Tyres*	Body blocks	Total lift
Not required	up to 50mm	up to 25mm	0mm	up to 75mm
Required	up to 75mm	up to 25mm	up to 50mm	up to 150mm
TMR approval	On application	On application	On application	On application

*Tyre lift heights specified are 50% of the tyre diameter, and do not apply to passenger cars other than 4 wheel drives (MC, NA and NB1 vehicles). For more information, refer to the section on Tyres and Rims.

Other modifications that are combined with the lift, such as changes to steering, suspension or wheels must comply with the National Code of Practice for Light Vehicle Construction and Modifications. For more information please refer to the [LS section](#) of the National Code of Practice for Light Vehicle Construction and Modification.

Lowering of vehicles

A vehicle may be lowered provided the vehicle maintains a minimum running clearance of 100mm and the requirements in Australian Design Rule (ADR) 43/... are met*

*Generally, a vehicle which maintains a minimum clearance of 100mm between the ground and any point on the underside of the vehicle, except a point on a tyre, wheel, wheel hub, brake backing plate or flexible mudguard or mudflap, will meet ADR 43/....

Variable Air or Hydraulic Suspension Systems

Airbag or air pressurised shock absorber helper springs may be fitted in addition to the original suspension. However, replacing some or all of the suspension system with an air or hydraulic suspension requires specific approval from TMR.

Suspensions Sway Bars, Torque Rods and Traction Rods

Auxiliary suspension control devices may be fitted without specific approval, provided they are properly engineered and secured and do not affect minimum ground clearance.

Adjustable sway bars, torque rods and traction rods may be fitted, provided they are designed and manufactured in accordance with good engineering practice, are suitable for on-road use and do not alter the vehicle suspension or steering geometry while used on the road network.



Shock Absorbers

Replacement shock absorbers, including struts and strut inserts, may be fitted without specific approval, provided they have been manufactured as replacement units for the particular vehicle model and have compatible mountings and dimensions.

Anti-roll Bars

Replacement or additional anti-roll bars, sway bars and stabiliser bars, may be fitted without specific approval to front and rear suspensions. Because additional roll stiffness at the front will increase understeer and additional roll stiffness at the rear will increase oversteer, the incorrect choice or combination of sway bars could lead to unpredictable handling. Additional assessment may be required and, if necessary, expert advice should be sought.

Track Rods

Track rods may be fitted without specific approval to control rear spring *wind-up* provided that they meet the minimum ground clearance requirements of Australian Design Rule 43 or the in-service requirements in the [Transport Operations \(Road Use Management - Vehicle Standards and Safety\) Regulation 2010](#) where applicable.

Strut Braces

Transverse strut braces may be fitted without specific approval between suspension strut and spring mounting towers. Front strut braces should be kept as low as possible below the bonnet to minimise head injury to a pedestrian from any downward impact on the bonnet. Additionally, the fitment of a strut brace must not adversely affect a vehicle's supplementary restraint system or crumple zone.

Welding, Chrome Plating, Heating or Bending of Axles, Suspension and Steering Components

The welding, chrome plating, heating or bending of axles, suspension or steering components, as a method of repair or alteration, is not permitted.

Differentials

Permanently locking a differential by welding or other means is not permitted and has a dangerous effect on the handling of a vehicle.

Body

Glazing (Windscreen and Windows)

Transparent material such as glass or acrylic, used in a windscreen, window or interior partition of a motor vehicle manufactured after June 1953 must have the characteristics required by any of the following standards:

- Australian and New Zealand Standard S/NZS 2080 Safety Glass for Land Vehicles
- British Standard BS AU178: Road Vehicle Safety Glass
- Japanese Industrial Standard JIS R 3211 Safety Glazing Materials for Road Vehicles
- American National Standard ANSI Z26.1 Safety Code for Safety Glazing Materials for Glazing Motor Vehicles Operating on Land Highway
- United Nations Economic Commission for Europe (UNECE) Regulation 43/00 Uniform Provisions Concerning Approval of Safety Glazing and Glazing Materials
- New Zealand Standard (NZS) 5443.



Window Tinting

No material or other object is to be located on the windscreen or windows which will interfere with the driver's vision.

Film which has a reflectance of more than 10 per cent must not be used on any windscreen or window.

Windscreens

Tinting may be applied to the upper portion of a windscreen of a motor vehicle. The tinting must not extend lower than a horizontal line connecting the uppermost points of the arcs swept by the vehicle manufacturer's original wiper blades or the upper 10 per cent of the windscreen, whichever is the lesser. The tinting may be of any shade.

Windscreens which have tinting incorporated within the glazing (not applied tint) are permitted subject to the screen having an optical transmission of not less than 75 per cent for a motor vehicle built after 1971 and 70 per cent for any other vehicle.

Vehicles with Non-tinted Glass

Window tinting, other than the front windscreen, must have a light transmittance factor of no less than 35% (T35) on the drivers and passenger front windows. Provided the vehicle has a rear vision mirror on each side, it may have window tint of not less than 20% (T20) light transmittance behind the driver's seating position.

A goods vehicle may have a luminous transmittance of 0% or more provided the vehicle has a rear vision mirror on each side.

Vehicles with Factory-tinted Glass

Most new vehicles are fitted with tinted glass consisting of tinted film incorporated within the glazing. In some cases it may be difficult to determine if the glass is actually tinted. To check if the glass is tinted, hold a piece of white paper on the opposite side of the glass. If it has a slight grey, green or brown colour when viewed through the glass, the glass is tinted.

Special grades of film, including clear film, may be applied to factory tinted windows. When these films are applied to tinted glass, the combination of tints must still allow a minimum light transmittance of 35 per cent on the drivers and passenger front windows and 20% (T20) on the rear windows.

Please note: The Australian Design Rules (ADRs) now allow privacy glass to be fitted to a vehicle rearwards of the driver's vision. Privacy glass has no minimum light transmittance and is often darker than T20 tint. Privacy glass incorporates tinted film within the glazing and is not defined as an applied tint. All applied tint must meet the above requirements and not the requirements set out for privacy glass in the ADRs.

For further information please refer to the [LZ section](#) of the National Code of Practice for Light Vehicle Construction and Modification.



Steering Wheels

It is acceptable to replace a vehicle's steering wheel without specific approval, provided the replacement steering wheel does not affect compliance with ADR 10 (after 1970) and ADR 69 (after June 1995). Unless a steering wheel is marked or has accompanying information indicating it has been tested to the appropriate ADR, it must not be used as a replacement. In addition, for vehicles required to comply with ADR 69, the steering wheel assembly must be identical to one fitted as an option to the same model by the vehicle manufacturer, or alternatively, a steering wheel that has been certified by the replacement wheel manufacturer as a complying wheel for the specific make and model may be used.

Replacement steering wheels should not be less than 330mm in diameter. If the original steering wheel was designed with a recessed or padded hub, the replacement wheel should be of a similar design.

Please Note: Removable steering wheels must not be fitted.

Electrical System

It is permissible to relocate a vehicle's battery without specific approval, provided it meets the following requirements:

- the battery is adequately restrained
- battery cables are shielded to prevent damage
- rubber grommets must be fitted where a cable passes through a hole in body panels and/or chassis sections
- battery cables are securely mounted to the vehicle at a maximum spacing of 600mm
- battery cables are adequate to carry the electrical system's maximum load.

Please note: In addition to the above requirements, a battery relocated in a vehicle's luggage compartment must be fully enclosed and the enclosure vented to outside the vehicle, unless a special kind of battery, for example, a sealed gel cell is used.

Lighting Systems

An additional light or reflector may be fitted without specific approval only if the light or reflector is required or permitted to be fitted by the Australian Design Rules (ADRs), the *Transport Operations (Road Use Management - Vehicle Standards and Safety) Regulation 2010* or another Act. For example, under-body lighting (neon lights) would **not** be acceptable. However, additional lights such as side marker lamps, brake lights and driving lamps are permitted.

Please Note: The use of blue lights is reserved for exempt vehicles such as police and ambulances vehicles only.

For further information, please refer to the [Transport Operations \(Road Use Management - Vehicle Standards and Safety\) Regulation 2010](#).

Headlights

Retro-fitting High Intensity Gas-Discharge (HID) or Light Emitting Diode (LED) headlight assemblies to vehicles not originally offered with the technology is generally not permissible as they do not comply with the ADRs because:

- no headlight self-levelling device is fitted
- no self-cleaning function is fitted
- the design of the headlamp reflector is incompatible with the bulb (the light is not focused correctly).

Main (high) Beam Headlamps

The fitting of additional main beam headlamps is permitted without specific approval as they are mentioned under the ADRs and the [Transport Operations \(Road Use Management - Vehicle Standards and Safety\) Regulation 2010](#). These additional lights may be fitted at any height above the ground but must only be fitted to the front of the vehicle.

Driving Lamps

The fitting of driving lamps, including LED light bars, is acceptable without specific approval, provided they meet the requirements provided in the ADRs.

Further information relating to driving lamps can be found in Vehicle Standards Instruction L15 *Driving lamps, including Light Emitting Diode (LED) light bars on light vehicles*.

Daytime Running Lamps and Fog Lamps

The fitting of daytime running lamps and/or fog lamps is acceptable without specific approval, provided they meet the requirements provided in the ADRs.

Information relating to daytime running lamps and fog lamps can be found in Vehicle Standards Instruction G20 *Front fog lamps and Daytime Running Lamps*.

Vehicle Accessories and Equipment

It is the owner's responsibility to ensure all accessories and equipment attached to a motor vehicle are designed and fitted in a manner which reduces the risk of injury to pedestrians and other road users who may make contact with the vehicle when the vehicle is parked or in motion.

Items such as driving lights, winches and brackets may be fitted without specific approval, provided they do not protrude forward from the front face of any bumper or above the top of any bull bar.

Fishing rod holders can only be fitted providing they comply with the following conditions:

- the fitting allows the driver a view of the road and of traffic to the front and sides of the vehicle
- they must only be attached to the left side of the vehicle.
- they must be designed to carry no more than four fishing rods.
- rods, hooks and sinkers must be properly secured.
- vehicle lighting must not be obstructed by rods or holders.
- rod holders must be either removed or retracted behind the profile of the bull bar when they are not in use.

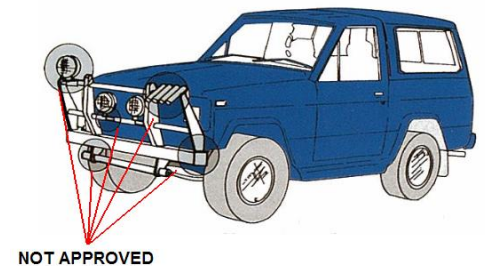

Bicycle/Wheelchair/Roof Racks

Tow bar mounted bicycle and wheelchair carrying racks **must** be removed when not in use, unless specifically approved to remain attached. The bicycle or wheelchair and the carrying rack must not obscure any compulsory lighting or the number plate.

To address this problem, an accessory number plate may be attached to bicycle carriers or other carrying devices. No other copy of the vehicle number plate is acceptable. The accessory plate must be attached to the rear of the accessory so that it is legible for 20m. Additional lighting of the plate is not required.

Roof racks may be fitted without specific approval, provided they do not protrude more than 50mm beyond the drip mould, or for a vehicle without drip moulds, the outer profile of the roofline.

Ladder Racks/External Roll Bars and Roll Cages

Vertical upright supports may be positioned behind and/or in front of the windscreen 'A' pillar. However, supports mounted in front of the windscreen 'A' pillar must not exceed 50mm in diameter and **must** be removed from the vehicle when not in use. Any support positioned in a way which can reflect the vehicle's lights back to the driver must be a matt black, non-reflective finish.

Ideally, no lights should be obscured by the fitting of any vertical support. If any light is obscured, an additional light must be fitted or the original relocated in accordance with the [Transport Operations \(Road Use Management - Vehicle Standards and Safety\) Regulation 2010](#) or Australian Design Rules.

Supports, braces and brackets must not have any sharp edges or protrusions, must not interfere with a person's normal access to the vehicle and should not project more than 150mm from each side of the vehicle or make the vehicle more than 2.5m wide.

Any attachments or modifications to the vehicle's chassis must be in accordance with the vehicle manufacturer's recommendations.

Please note: Requirements for internal roll bars and roll cages are covered in the [LK section](#) of the National Code of Practice for Light Vehicle Construction and Modification.

Long Range Radio Antennas

Long range antennas may be fitted to a vehicle without specific approval, provided they meet the following requirements:

- Forward mounting is permitted only when it is impossible or impractical to install the antenna to the rear of the vehicle.
- The installation must be attached as low as is practical to ensure the large diameter section of the antenna projects above the bonnet line for the minimum distance.
- Only one long range antenna (large diameter base) may be fitted to the front of a vehicle and must be fitted to the left side (maximum diameter permitted 75mm).
- All sharp edges or protrusions which could cause injury to anyone making contact with the device must be removed or rounded.



Visual Display Units

Visual display units such as DVD screens, reversing cameras, and so on may be installed in a motor vehicle without specific approval. However, no part of the image on the screen may be visible to the driver in the normal driving position unless the screen is disabled when the vehicle is being operated or it is considered a driver's aid, for example, in-car navigation.

When fitted, the unit must not:

- be positioned in a way which adversely affects the driver's field of view. It is recommended that the driver maintains an 11 metre (or if less, that provided for by the original vehicle manufacturer) field of view from the driver's seating position with the seat in the lowest and rearmost position

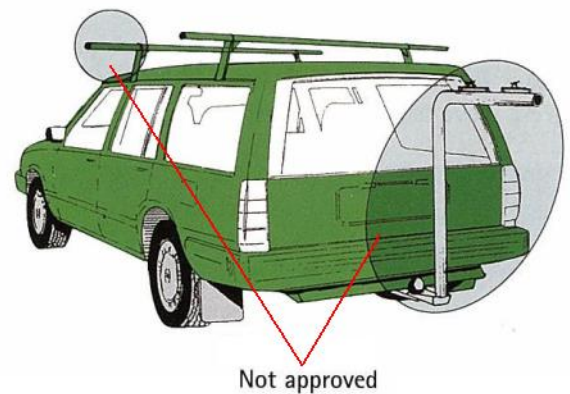

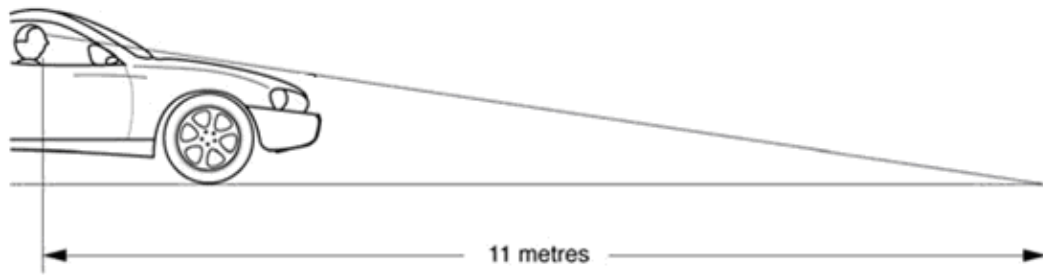

- encroach upon the deployment area of any of the vehicle's Supplementary Restraint Systems (Air bags, seatbelts, head restraints, etc.)
- impede the movement of occupants in the vehicle
- be fitted in a location which could contact occupants in the event of a crash
- be fitted in a location where any image on the screen is likely to distract other drivers
- be fitted in a way such that it can easily dislodge in a crash or under heavy braking/acceleration
- obstruct occupant access into the vehicle.

Further information relating to visual display units can be found in Vehicle Standards Instruction G3 *Fitting of visual display units in vehicles*.

Accessory Gauges

Additional internal or external gauges may be fitted to a vehicle without specific approval, provided they do not:

- interfere with the field of view of the driver
- produce glare to the driver
- pose a risk of pressurised fluids spraying onto the windscreen, for example, from an oil line, coolant line
- increase the risk of injury to a vehicle occupant or vulnerable road user in the event of a collision
- encroach upon the deployment area of any of the vehicle's Supplementary Restraint Systems, such as air bags, seatbelts, or head restraints.

Bonnet Scoops

Bonnet scoops/projections may be fitted to a vehicle without specific approval, provided they meet the following requirements:

- the driver's vision is not restricted under normal operating conditions with the driver's seat located at its lowest and rearmost position.
- When a 165mm diameter sphere is placed on the bonnet in front of the scoop or bonnet projection and rolled backwards until it touches the scoop, no forward point of the scoop or point of contact between the sphere and the scoop must lie above a horizontal plane passing through the centre of the sphere.

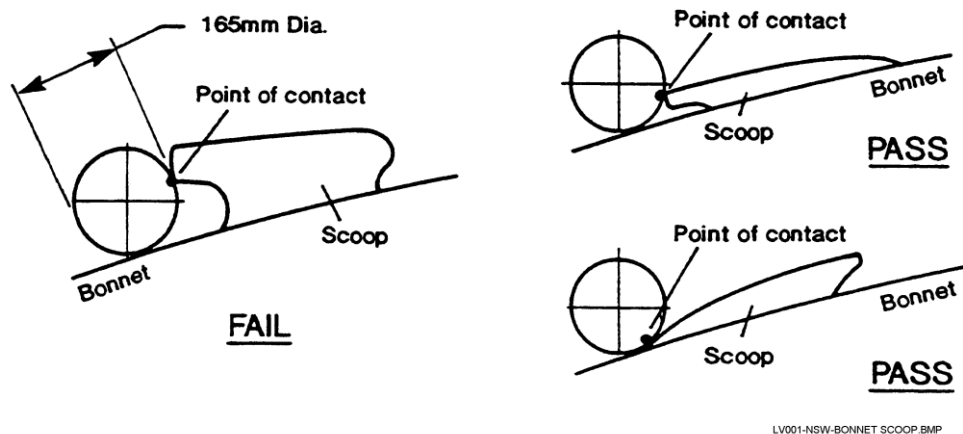

- It shall be possible to see either the surface of the road 11m in front of the driver's eye or all of the front edge of the original body when looking across the top of the bonnet scoop. For the purposes of this requirement, the driver's 'eye' position can be taken as being a point 730mm above and 270mm forward of the junction of the seat cushion and seat back with the seat in its lowest and rearmost position.

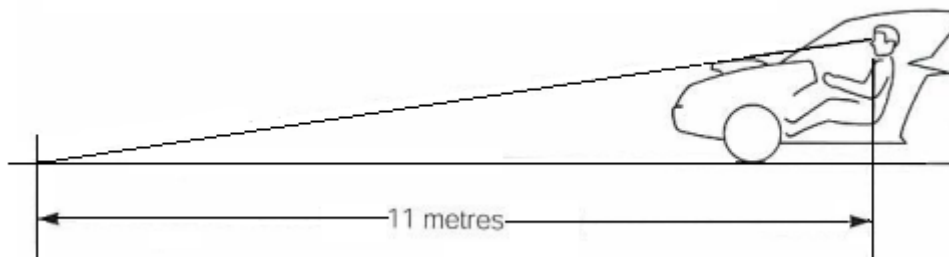

- The edges at the front of a scoop/projection shall be rounded with a minimum radius of 10mm.
- All other edges and corners shall have a radius of not less than 5mm and be designed to reduce the risk of bodily injury to any person.
- The scoop/projection must not have reflective surfaces.
- Any holes in the bonnet must not substantially reduce the strength or impact resistance of the bonnet.
- Air cleaners or carburettors must not protrude beyond the original bonnet profile unless the bonnet scoop/projection is manufactured from equivalent gauge mild steel, compared with that of the original bonnet.
- Air cleaners and/or carburettors must be covered by the bonnet scoop.

For further information please refer to the [LH section](#) of the National Code of Practice for Light Vehicle Construction and Modification

Side Skirts, Flares and Spoilers

Side skirts and front and rear spoilers may be fitted without specific approval, provided road clearance and air flow for brake cooling are not adversely affected.

Additionally, they must not be fitted so they are likely to increase the risk of bodily injury to a vulnerable road user coming into contact with the vehicle. All material is to be of a suitable thickness and be free from sharp edges or corners.

Rear spoilers must be within the body shape/outline of the mounting surface, for example, the boot outline. The minimum thickness of end plates is 4mm and they must be free of sharp edges or corners.

For further information please refer to the [LH section](#) of the National Code of Practice for Light Vehicle Construction and Modification



Bull Bars

Bull bars may be fitted without specific approval, provided they are designed and fitted so that the safety of the vehicle is not adversely affected. They must be firmly and securely mounted and supported and must not constitute a danger to other road users. Bull bars must not obstruct the vision of the driver and should not project further from the front of the vehicle than is necessary for their attachment. Bull bars should not add a significant load to the front suspension.



Bull bars must be free of sharp protrusions and all exposed sections of the bull bar and fittings must be radiused and deburred. Forward and side members should be designed to reduce the risk of injury to any person who may come into contact with the bull bar.

Bull bars must not obscure the driver's view or any light. In particular, the visibility of indicator lights at all viewing angles must not be reduced or, if they are, additional lights must be fitted or the original relocated in accordance with the relevant legislation or ADRs. Surfaces of the bar that could reflect light from the vehicle's headlights must be matt black.

Vehicles fitted with an airbag or manufactured to comply with Australian Design Rule (ADR) 69 - Full Frontal Impact Occupant Protection, or both ADR 69 and ADR 73 – Offset Frontal Impact Protection can only be fitted with a bull bar which:

- has been certified by the vehicle manufacturer as suitable for that vehicle, or
- has been demonstrated by the bull bar manufacturer to not adversely affect compliance with the ADRs or interfere with the critical airbag timing mechanism.

Bull bars must comply with Australian Standard (AS) 4876.1-2002, sections 1, 2 and 3.1. In addition, TMR recommend bull bars comply with section 3.2 of AS 4876.1-2002.

Bodywork and Interior

There are general requirements concerning alterations to the bodywork, however:

- no alteration may cause a hazard to persons due to exposed sharp edges or projections, and
- no alteration may cause a reduction in the level of safety or overall strength of the vehicle.

Tyres and Rims

Alternative Tyres and Rims

Many vehicle owners like to replace the vehicle's original tyres and rims with alternatives of different width, diameter and profile.

The following sub-sections outline the legal requirements for replacement tyres and rims fitted to a passenger car or derivative, or to an off-road passenger car, which will ensure your vehicle continues to comply with Queensland legislation, while allowing for your individual preferences.

For a passenger car, passenger car derivative or 'soft roader' (an all-wheel drive vehicle other than MC category), the overall diameter of any alternate tyre fitted may be up to 15mm larger or 26mm smaller than that of any tyre designated by the vehicle manufacturer for that model.

The overall diameter of any alternate tyre fitted to any of the following types of vehicles may be up to 50mm larger or 26mm smaller than that of any tyre designated by the vehicle manufacturer for that vehicle.:

- a passenger vehicle specifically designed for off-road use (MC ADR category);
- a light goods vehicle (NA ADR category) with 4WD or 2WD configuration
- a medium weight goods vehicle with GVM up to 4500 kg (NB1 ADR category) and with 4WD or 2WD configuration;

Note: Speedometer accuracy must be maintained for the selected tyre and rim combination.

Replacement tyres must also conform to the following requirements:

- The tyres must be rated by the tyre manufacturer as being suitable for road use.
- When fitting passenger car tyres to light goods vehicles originally fitted with light truck tyres, the load rating of the replacement tyres must be based on the highest individual wheel load multiplied by a service factor of 1.10.
- The tyres on a given axle must be of the same construction (e.g. radial) and of the same size.
- Where retreaded tyres are used, they must have been retreaded and marked in accordance with the provisions of Australian Standard (AS) 1973-1993 Pneumatic Tyres — Passenger Car, Light Truck and Truck/Bus — Retreading and Repair Processes.

Low profile tyres (e.g. 50 series), which replace standard profile tyres (e.g. 70 series or above), are normally fitted in combination with rims of larger than standard diameter to maintain the correct overall diameter of the wheel. A diagram of this concept appears to the right.

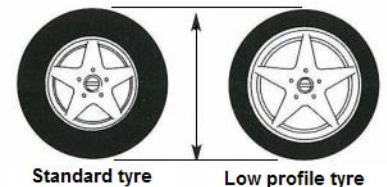

Tyre Aspect Ratio

Because of the different handling characteristics, the aspect ratio of tyres fitted to the front axle must not vary by more than 10 from the aspect ratio of tyres fitted to the rear axle (e.g. 175 **65** R14 front and 205 **45** R14 rear, has an aspect ratio difference of 20 and is not permitted, whereas 175 **65** R14 front and 195 **60** R14 rear has a difference of 5 and is permitted).

General Conditions for Alternative Rims and Tyres

The rims and tyres must not protrude beyond the bodywork of the vehicle, including flares, when viewed from above with the wheels facing straight ahead. If the vehicle was originally constructed with a portion of the wheel protruding, the alternative wheels must not protrude further than the original ones.

The tyre to rim fitting and the tyre to rim combination must be in accordance with the Tyre and Rim Standards Manual published by the Tyre and Rim Association of Australia. Reputable tyre retailers should have this information and be able to advise on the correct combinations.

All rims fitted to an axle must be of the same diameter, width and offset. They must not have a circumferential weld other than that which attaches the outer rim to the centre. All rims must have stud hole pitch circle diameters suitable to the hub. Wheel nut tapers must be appropriate to the wheel and must engage the thread of the wheel studs for at least the same length as the nuts provided by the vehicle manufacturer.

Slotted and elongated stud holes are not permitted.



The fitting of spacers or adaptors between wheels and hubs, other than those provided by the vehicle manufacturer, is not permitted.

The tyre and rim must not foul wheel arches or suspension components under any conditions. Steering limit stops must not be adjusted to reduce the turning circle in order to allow the fitting of the alternative rims and tyres.

The tyres must have a tread depth of at least 1.5mm on every part of the tyre that touches the road and not have any apparent defect that is likely to make the vehicle to which they are fitted unsafe.

Fitting tyres that have been treated by recutting or regrooving is not permitted unless the tyre has been marked by the original manufacturer as 'suitable for recutting or regrooving'. Regrooving that exposes chord or steel is not permitted.

The maximum tyre width for a car or car derivative must not be more than 1.3 times the vehicle manufacturer's widest optional tyre.

However, for an off-road passenger vehicle fitted with front and rear beam axles, the maximum tyre width must not be more than 1.5 times the vehicle manufacturer's widest optional tyre.

The nominal width of the narrowest tyre fitted to a vehicle must not be less than 70 per cent of the nominal width of the wider tyre fitted and never less than the vehicle manufacturer's narrowest optional tyre as indicated on the manufacturer's tyre placard.

Speed and load ratings

The speed rating of all tyres must be at least:

- for an off-road passenger vehicle – 140km/h
- for another car (sedan, station wagon, etc.) with up to nine adult seating positions or a car derivative – 180km/h
- for another motor vehicle – 120km/h
- the vehicle's top speed, if lower than the speeds referred to above.

Load ratings of tyres must be at least equal to those specified by the manufacturer on the tyre placard fitted to vehicles made after 1972. For other vehicles, the load rating of a tyre must be capable of carrying the part of the vehicle's gross mass carried by the tyre.

Tyre Construction

Tyre tread compounds, patterns, ply ratings and performance characteristics vary. Tyre construction (e.g. radial) and size must be the same on the same axle. Although it is recommended that the tyres are identical (e.g. same brand and tread pattern), this is not mandatory.

Wheel Marking

Vehicles built on or after 1 July 1985 must be fitted with original wheels or replacement wheels which are indelibly marked in accordance with approved standards.

These standards include:

- Standards Australia
- Wheel Industries Association (Australia)
- Technischer Überwachungen Verein
- Japanese Industrial Standards.

Composite Wheels

The use of composite wheels (two or three-piece) is permitted. They must be manufactured and marked in accordance with the standards described above if fitted to vehicles manufactured on or after 1 July 1985.

Repairs to Tubeless Tyres

Permanent repairs can only be made when the tyre is removed from the rim. The tyre must be examined to ensure it is structurally sound. The damaged area must be prepared on the inside for a patch or mushroom headed plug to be fitted

and vulcanised into position. Any repairs to a tyre must be sealed to prevent moisture or contaminants from entering the tyre casing or structure.

Caution: Plug repairs can only be made in the tread area of the tyre and not in sidewalls or where the tread and sidewall meet.

Punctures in tubeless tyres must not be repaired from the outside or without removing the tyre from the rim as this method is prone to failure.

Vehicle owners with doubts about tyre repairs should contact a reputable tyre dealer for proper repairs.

For further information on tyres and rims, please refer to the [LS section](#) of the National Code of Practice for Light Vehicle Construction and Modification.

Vehicle Track

Track is measured at ground level from the centre of the tyre on one side to the centre of the corresponding tyre on the opposite side of the vehicle. The front and rear track differs on many vehicles.

The wheel track of passenger cars (or derivatives) must not be increased by more than 25mm beyond the maximum specified by the vehicle manufacturer for the particular model. This means that the rim offset must not be changed by more than 12.5mm.

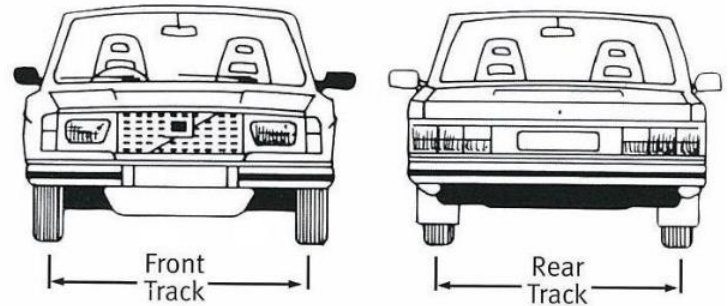

The wheel track of off-road four wheel drive vehicles and goods vehicles must not be increased by more than 50mm beyond the maximum specified by the vehicle manufacturer for the particular model. If a solid axle from another manufacturer is used, the wheel track may be increased by 50mm beyond the maximum specified by the vehicle manufacturer for that particular axle, provided all other requirements such as clearances are met and the tyres do not protrude outside of the vehicle bodywork.

This does not apply to passenger vehicles that are four wheel drive or all-wheel drive and certified as MA category vehicles on the vehicle identification plates. A vehicle's identification plate can usually be located under the bonnet on the vehicle's firewall or inside the driver's door jamb.

Please Note:

The wheel track of any vehicle must not be reduced to less than the standard track specified by the vehicle manufacturer for the particular model of vehicle.

On vehicles with diagonally split brake systems, the front wheel offset (and front wheel track) should remain as original, except where the original manufacturer specifies differently with optional rims for a particular model.

For further information please refer to the [LS section](#) of the National Code of Practice for Light Vehicle Construction and Modification.

Motorbikes

Frame and Suspension Alterations

Motorbike design is a complex task. Before modifications are made to a motorbike's frame or suspension, you should be aware that structural changes to the frame, steering head, front forks, suspension, brakes or wheels may load vital components well beyond the limits for which they were originally designed. This may increase the probability of failure and may be a danger to the rider and other road users. Motorbikes with properly designed custom frames, extended forks, hard tail conversions and structural modifications are acceptable, but require approval by TMR. Before undertaking modifications similar to the ones mentioned above you must engage the services of an Approved Person Engineer.



Engine Replacements

Many manufacturers produce a series of models with the same basic frame fitted with engines of differing capacity. No approval is required if the smaller capacity engine is replaced by a larger capacity engine from the same series, provided the brakes and suspension from the larger capacity motorbike are fitted and no modification is required to the frame. The fitting of any other alternative replacement engine, superchargers or turbochargers will require approval by TMR. Before undertaking modifications similar to the ones mentioned above, you must engage the services of an Approved Person Engineer.

Steering Gear and Handle Bars

For motorbikes which have the head stem as the steering pivot point, the horizontal distance from the midpoint between the head stem bearings to the centre of the front wheel must not be over 550mm. Offset triple clamps are often fitted to provide the motorbike with 'a raked out' appearance without the need to modify the frame. These are acceptable, provided the trail measurement is not less than 75mm.

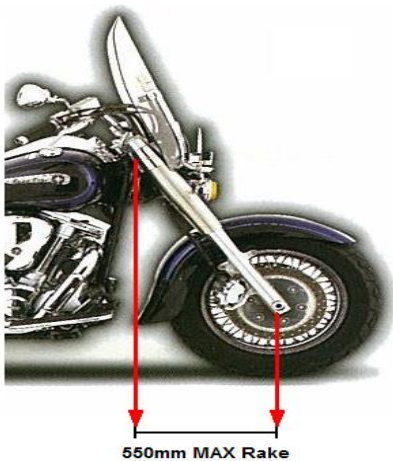

Motorbike Rake

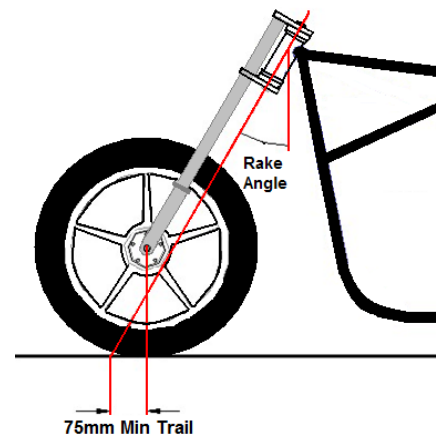

Motorbike Trail

Motorbikes manufactured before 1 July 1988

The handle bars of a motorbike must extend at least 250mm, but not over 550mm, on each side of the longitudinal axis of the motorbike. This measurement does not include mirrors and lights. The lowest part of the hand grip on the handle bars must not be higher than 380mm above the attachment point of the handle bars to the motorbike. Hand grips on the handle bars must be fitted symmetrically. **Please Note:** When measuring handle bar height, the upper surface of the original steering yoke, not including any spacers, is considered the handlebar attachment point.



Motorbikes manufactured from 1 July 1988 The distance between the extreme ends of the handlebar must not be less than 500mm and not more than 1100mm. This measurement does not include mirrors and lights. The height of the lowest part of the handgrip must not be more than 380mm above the lowest part of the upper surface of the rider's seat. Hand grips on the handle bars must be fitted symmetrically.

Exhausts

Motorbikes manufactured from 1 July 1975 are subject to Australian Design Rule (ADR) requirements for noise. Any replacement exhaust system must be as near as practicable to the original component specification and/or comply with ADR noise requirements. If you modify or replace an exhaust system on a pre-1975 motorbike, you must remember that the law prohibits all motor vehicles from causing excessive noise due to the condition or construction of the vehicle, or the manner in which it is operated.

Motorbikes manufactured from 1 July 1988 have all components of the silencing system marked with the name or trade name of the manufacturer. These motorbikes carry information of the Stationary Noise Test in the following format:



STATIONARY NOISE TEST INFORMATION

Tested at..... dB(A) at..... r/min
Silencing System: (manufacturer's name)
Identification: (trade description)

Any replacement part of the silencing system must show the trademark or the name of the original manufacturer of the system.

Seat Reduction

Compulsory Third Party (CTP) insurance premiums on motorbikes are determined by the seating capacity of the motorbike. Conversion of a motorbike from a two-seater to a single-seater, or vice versa is considered to be a basic modification and can be carried out without the need for certification by an Approved Person. For two-seats to single-seat conversions, the maximum length of the upholstered section of the seat must be 500mm or less, and the pillion foot pegs must be removed with any associated brackets and threaded holes drilled out. You are not permitted to use a removable cowl or other structure fitted over the seat to reduce the length of the seat. For further information, please refer to the LL section of the National Code of Practice for Light Vehicle Construction and Modification.

Motorbikes must be fitted with footrests for the rider, and for any passenger for whom a seating position is provided.

Wheels and Tyres

On all wheels (including any side-car wheel), the tyre size must be suitable for the rim. Each tyre and rim must be strong enough to support the machine when it is fully loaded. Most major motorbike tyre specialists can tell you the right tyre and rim for your motorbike and the appropriate tyre speed rating.

Chain Guards (including Belt Drive)

If the motorbike has a chain or belt drive, the driver and any passenger must be protected from the front sprocket and at least the upper part of the chain or belt by the frame or equipment of the motorbike, or by a guard. The guard must cover the chain or belt to a point at least 300mm to the rear of the rearmost foot rest or above the centre of the rear drive sprocket.

Mudguards

Mudguards must be fitted to all wheels (including the sidecar wheel). Each mudguard must be at least as wide, over its entire length, as its respective tyre. A front mudguard must cover the rearward section of the wheel through the area between two lines, one vertical and the other horizontal, both drawn through the centre of the wheel. If suitable protection is afforded by the frame or construction of the motorbike, the front guard need only cover the unprotected area.

The mudguard provided for the rear wheel and for the wheel of any sidecar must:

- protect other road users, as far as practicable, against thrown-up stones, mud, ice, snow and water; and
- reduce the dangers due to contact with the moving wheels.

For further information please refer to Vehicle Standards Instruction M4.1 – *Motorcycle Mudguard Requirements*.

Indicators

Indicators are required on all motorbikes manufactured after 30 June 1975.

Sidecars

Sidecars which bolt directly to the motorbike's frame without the need for any modifications to the motorbike are acceptable without specific approval. However, sidecars which require the motorbike to be modified (for example, welding to the frame) must be approved by TMR. Before modifying your motorbike so that a sidecar can be attached, you should engage the services of an Approved Person Engineer.

When attached, a sidecar must be:

- fitted to the left hand side of a motorbike. However, this does not apply to a motorbike and sidecar combination greater than 30 years of age
- fitted with a mechanical parking brake if the motorbike was manufactured after February 1976
- such that the overall width of the motorbike and sidecar in combination, including any load and equipment, less than 1.86m
- fitted with a parking light within 150mm from the side of the sidecar that is furthest from the motorbike.

Minimum coverage, unless suitable protection is afforded by the frame.

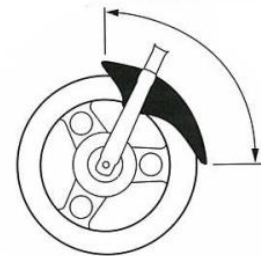

Front wheel

Additional Information

Australian Standards

<http://www.saiglobal.com/online/>

National Code of Practice for Light Vehicle Construction and Modification

(Vehicle Standards Bulletin 14)

<http://www.tmr.qld.gov.au/Safety/Vehicle-standards-and-modifications/Vehicle-modifications/Light-vehicle-modifications.aspx#ncop>

Queensland Code of Practice - Vehicle Modifications (QCOP)

<http://www.tmr.qld.gov.au/Safety/Vehicle-standards-and-modifications/Vehicle-modifications/Light-vehicle-modifications.aspx#qcop>

Transport Operations (Road Use Management—Vehicle Standards and Safety) Regulation 2010

<http://www.legislation.qld.gov.au/LEGISLTN/CURRENT/T/TrantOpRUVSSR10.pdf>

Third Edition Australian Design Rules

http://www.infrastructure.gov.au/roads/motor/design/adr_online.aspx

Tyre and Rim Standards Manual

Available to purchase from <http://www.tyreandrim.org.au/>

Vehicle Standards Instructions

<https://www.tmr.qld.gov.au/Safety/Vehicle-standards-and-modifications/Vehicle-standards/Vehicle-standards-instructions>